

**XL-ITR20403****技术数据表** Technical Data Sheet**对射式光电开关****特点 (Characteristic) :**

- \* 可靠性高、辐射强度高、低电压驱动  
High reliability 、 High radiant intensity 、 Low forward voltage
- \* 感应速度快、感光度强  
Fast response time 、 High photo sensitivity
- \* 截止感应波长940nm  
Cut-off visible wavelength  $\lambda_p=940\text{nm}$
- \* 无铅材料、Rohs认证  
Pb.Free 、 RoHS compliant version

**应用领域 (Product application) :**

- \* 投币机  
Slot machines
- \* 小家电  
Small home appliances
- \* 自动感应器  
Automatic Sensors
- \* 传真机  
Fax machine
- \* 扫描仪  
Scanner



---

目录

---

Catalogue

电性参数  
Electrical Characteristics.....3

典型特性曲线  
Typical Characteristic Curves.....5

外形尺寸  
Outline Dimensions.....8

包装  
Packaging.....9

焊接指导  
Guideline for Soldering.....10

使用注意事项  
Precautions.....12

电性参数

Electrical Characteristics

◆极限参数 (温度=25°C): Absolute Maximum Ratings (Temperature=25°C):

测试项目 Parameter		符号 Symbol	数值 Ratings	单位 Unit
输入端发射极 Input Emitter	功率 Power Dissipation*1	PD	75	mW
	正向输入电流 Continuous Forward Current	IF	50	mA
	脉冲正向电流 Peak Forward Current*2	IF	1	A
	反向电压 Reverse Voltage	VR	5	V
输出端接收极 Output Detector	功率 Power Dissipation*1	PD	75	mW
	集电压-发射极电压 Collector-Emitter Voltage	VCEO	30	V
	发射极-集电极电压 Emitter-Collector Voltage	VECO	5	V
	集电极电流 Collector Current	IC(on)	20	mA
工作温度 Operating Temperature		Topr	-20~+85	°C
储存温度 Storage Temperature		Tstg	-40~+85	°C
焊接温度 Lead Soldering Temperature*3		Tsol	260	°C

光电参数 (温度=25°C) :

Electro-Optical Charasteristics (Temperature=25°C):

参数 Parameter		符号 Symbol	测试条件 Testconditions	最小 Min	平均 Typ	最大 Max	单位 Unit
输入端 Input	正向电压 Forward Voltage	VF	IF=20mA	--	1.2	1.5	V
	峰值波长 Perk Wavelength	$\lambda P$	IF=20mA	--	940	--	nm
	反向电流 Reverse Current	IR	VR=5V	--	--	10	$\mu A$
输出端 Output	暗电流 Dark Current	ICEO	Ee=0mW/cm <sup>2</sup> VCE=20V	--	1	100	nA
	集电极-发射极的工作电压 C-E Saturation Voltage	VCE(SAT)	IC=2mA Ee= 1mW/cm <sup>2</sup>	--	--	0.4	V
转换特性 Transfer Characteristics	上升时间 Rise Time	tr	VCE=5V IC= 1mA RL= 1000 $\Omega$	--	15	--	$\mu S$
	下降时间 Fall Time	tf		--	15	--	
	光电流 Collector Current	IC(ON)	IF=20mA VCE=5V	0.2	--	5	mA

备注(Note):

- \* 在 25 摄氏度的环境中测试 below 25 Free Air Temperature
- \* 脉宽少于等于 100us , 占空比 1% Pulse width  $\leq$  100 $\mu s$ , Duty cycle= 1%
- \* 离胶体 2mm 以上焊接 5s 内 2mm form body for 5 seconds

## 典型特性曲线

### Typical Characteristics Curves

#### 发射管特性曲线图 Typical Electro-Optical Characteristics Curves-IR

正向电流与环境温度的关系

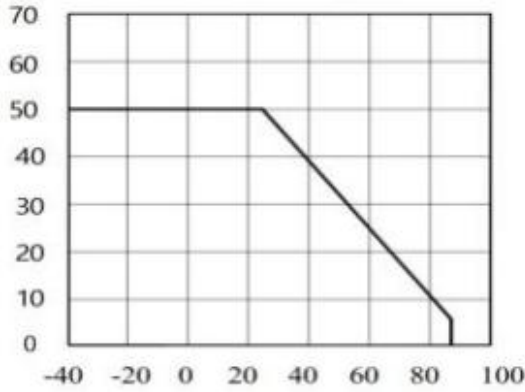

环境温度 Ambient Temperature(°C)

正向电流与正向电压的关系

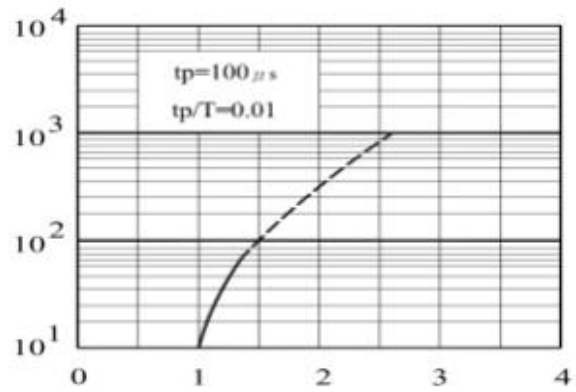

正向电压 Forward Voltage V

辐射强度与正向电流的关系

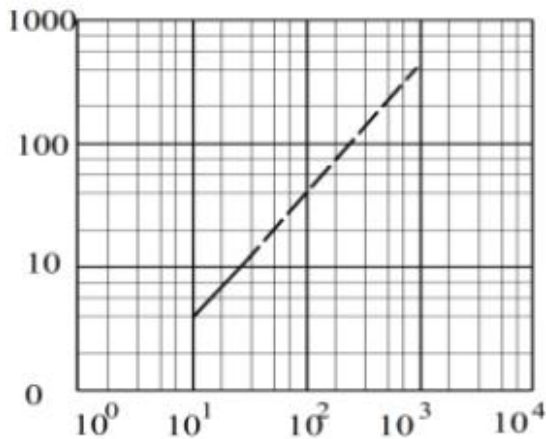

正向电流 Forward Current(mA)

波长曲线图

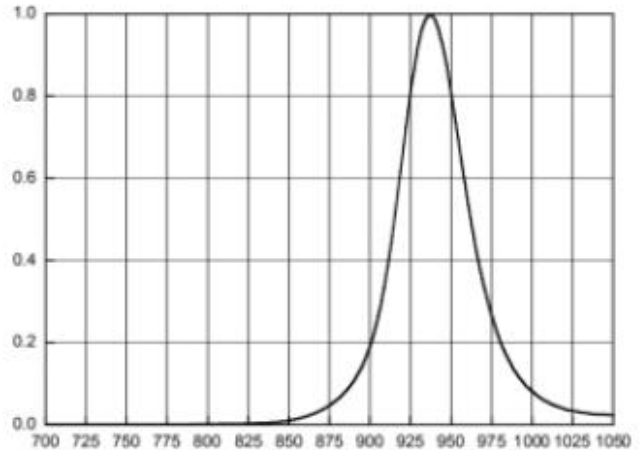

峰值波长 Wavelength(nm)

接收管特性曲线图 Typical Electro-Optical Characteristics Curves-PT

集电极功率与环境温度的关系

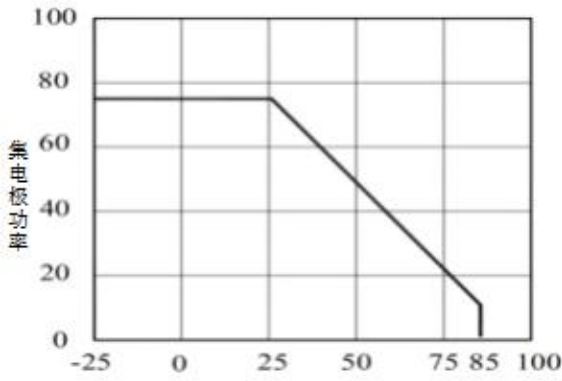

环境温度 Ambient Temperature(°C)

相对集电极电流与环境温度的关系

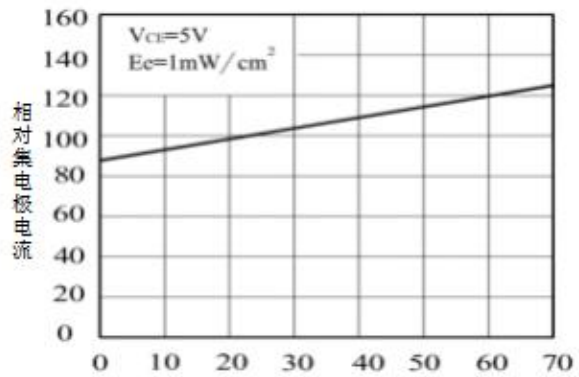

环境温度 Ambient Temperature(°C)

集电极暗电流与环境温度的关系

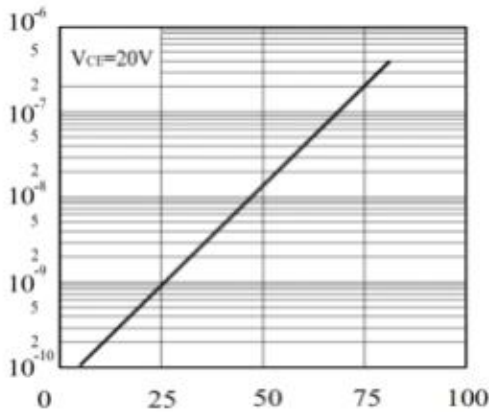

环境温度 Ambient Temperature(°C)

感应波长图

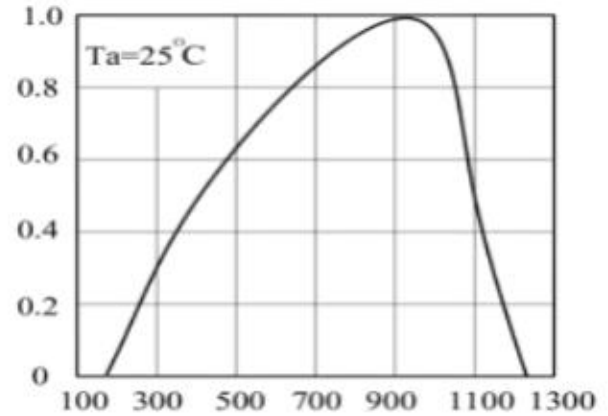

峰值波长 Wavelength(nm)

集电极电流与辐射强度的关系

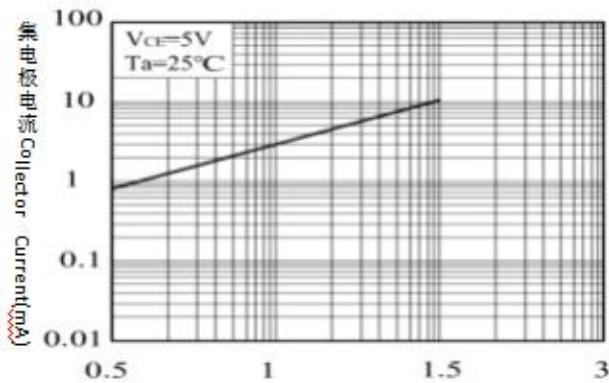

集电极电流与集电极-发射极电压的关系

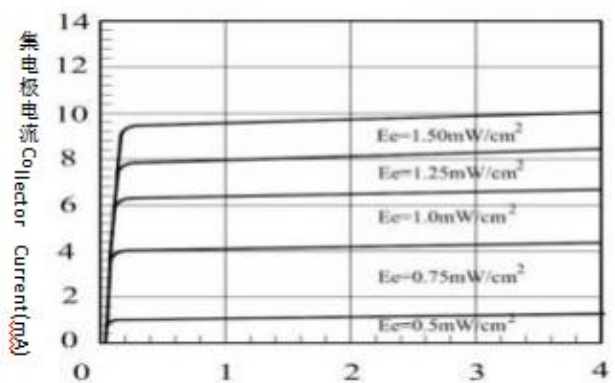

光电开关特性曲线图 Typical Electro-Optical Characteristics Curves-I

光电流与正向电压的关系

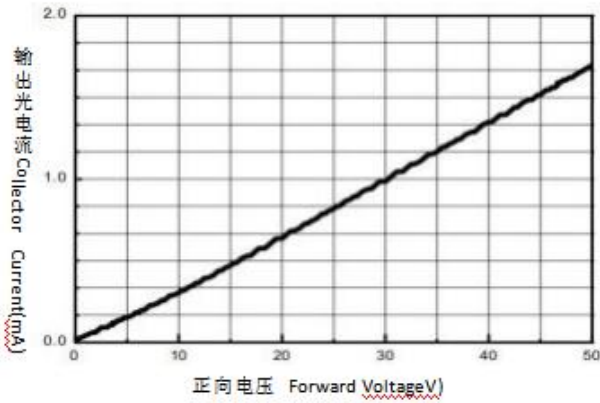

输出强度与环境温度的关系

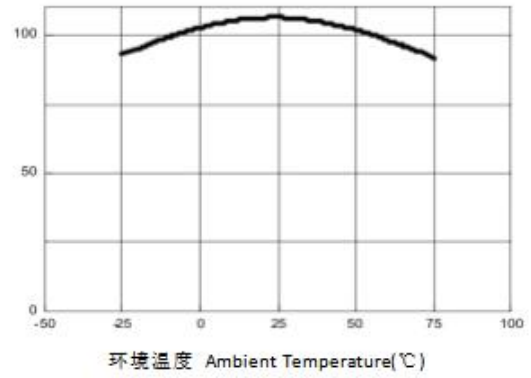

正向电流与正向电压的关系

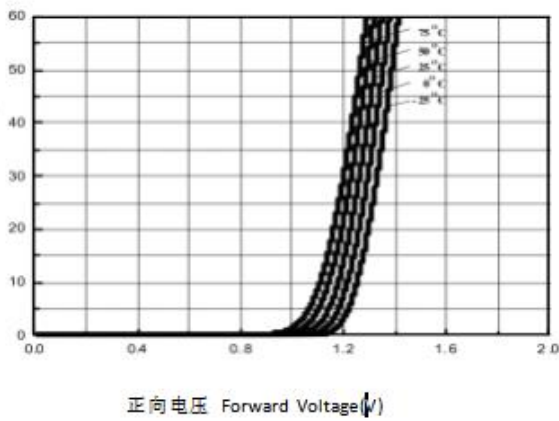

输出特性

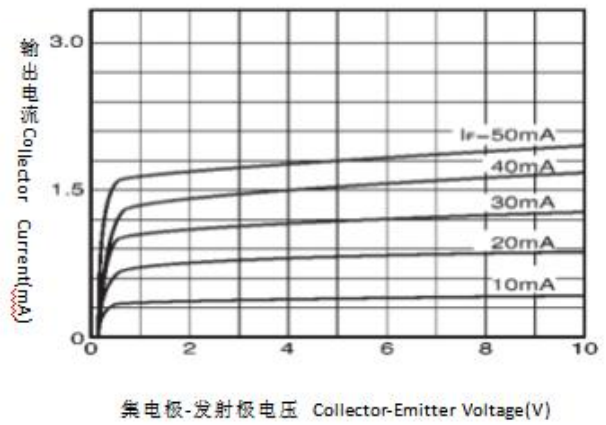



# 外形尺寸

## Outline Dimension

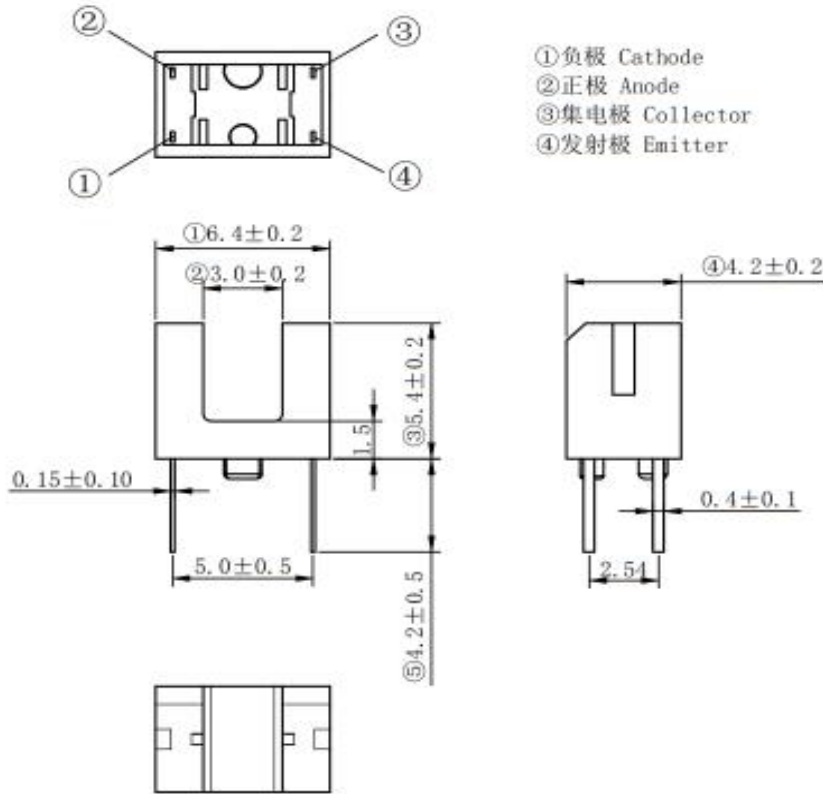

- 技术要求:
- 1、未标公差:  $\pm 0.20\text{mm}$ ;
  - 2、所有标注的尺寸均需检验, 其中①~⑤的尺寸需记录数据;
  - 3、切筋口无损伤, 筋口毛刺 $\leq 0.1\text{mm}$ , 管脚切口毛刺 $\leq 0.04\text{mm}$ ;
  - 4、引脚需镀银, 银层厚度要求 $\geq 0.75 \mu\text{m}$ ;
  - 5、引脚爬胶距离须控制在 $1.5\text{mm}$ 以内;
  - 6、IR和PT灯管拉拔力 $\geq 0.5\text{kg}$ ;
  - 7、符合本公司最新版本《环境管理标准》。

备注:

1.单位: 毫米 (mm)

Remarks: 1 Unit: mm

2.公差: 无特别标注则为 $\pm 0.3\text{mm}$

2. Tolerance:  $\pm 0.3\text{mm}$  unless otherwise specified



包装

Packaging

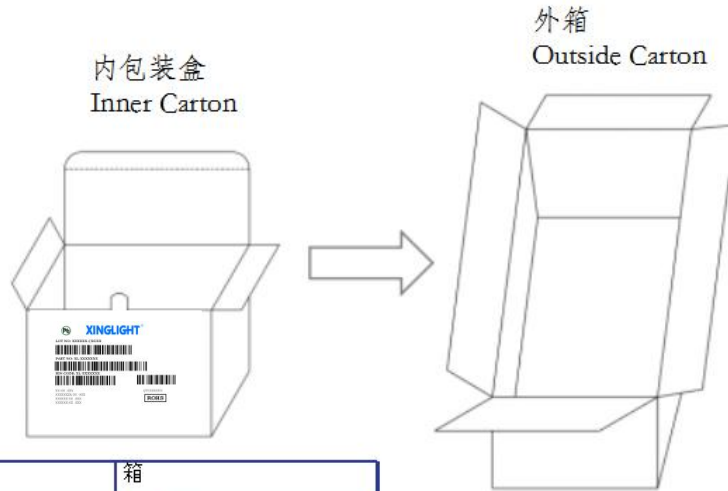

包装管	内盒	箱
120PCS/管	96管/盒	2小箱/箱

## 焊接指导

### Guideline for Soldering

推荐波峰焊曲线 The wave peak welding curve is recommended :

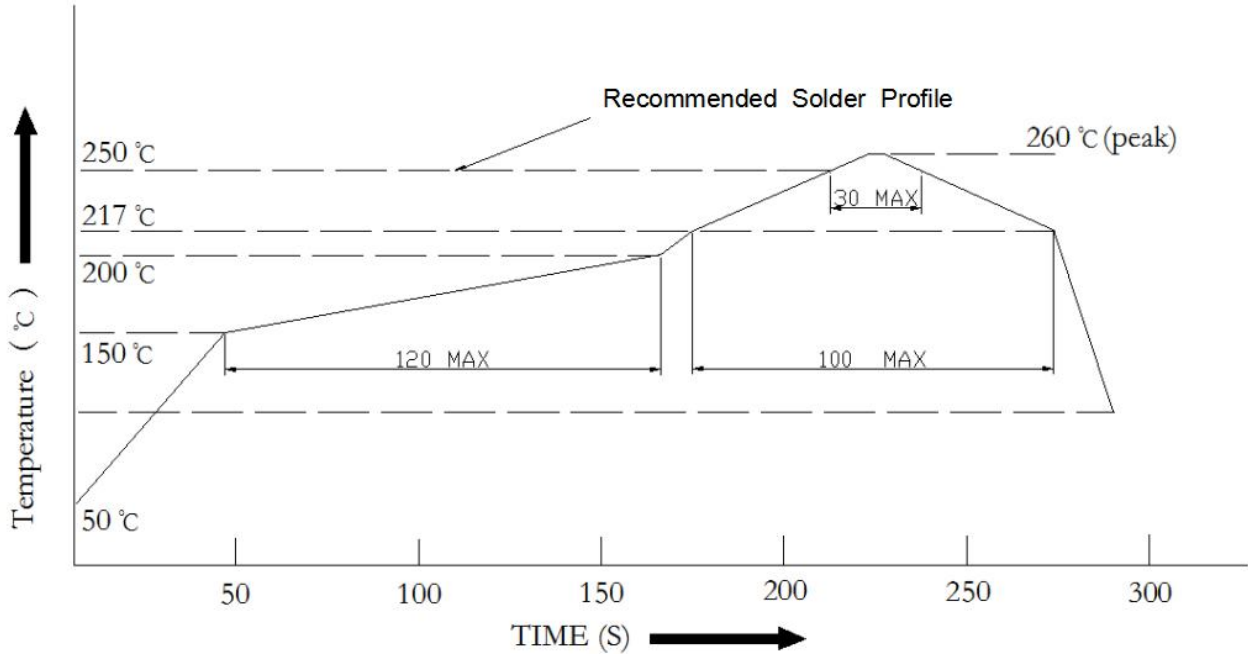

注意: Note

- 1、铅焊料温度剖面  
Lead solder temperature profile
- 2、波峰焊不应做一次以上  
Peak welding shall not be done more than once
- 3、焊接时，不要在加热过程中对 LED 施加压力  
When soldering, do not put stress on the LED during heating
- 4、焊接后，不要使电路板翘曲  
After soldering, do not warp the circuit board

## 烙铁条件 Soldering Iron

每个端子都要去烙铁尖端温度低于 300°C 为 3 秒内一次少于烙铁容量 25W 。 离开两秒钟然后更多的间隔，并做焊接每个终端。手工焊料通常在开始的时候容易损坏产品。

Each terminal is to go to the tip of soldering iron temperature less than 300°C for 3 seconds within once in less than the soldering iron capacity 25W. Leave two seconds and more intervals, and do soldering of each terminal. Be careful because the damage of the product is often started at the time of the hand solder.

## \*手工补数 Repairing

修理不应在 LED 焊接后进行。当修理是不可避免的是，应该使用双头烙铁 (如下图所示)。应该是事先确认 LED 的特性是否会或不会损坏通过修理。

Repair should not be done after the LED have been soldered. When repairing is unavoidable, a double-head soldering iron should be used (as below figure). It should be confirmed beforehand whether the characteristics of the LED will or will not be damaged by repairing.

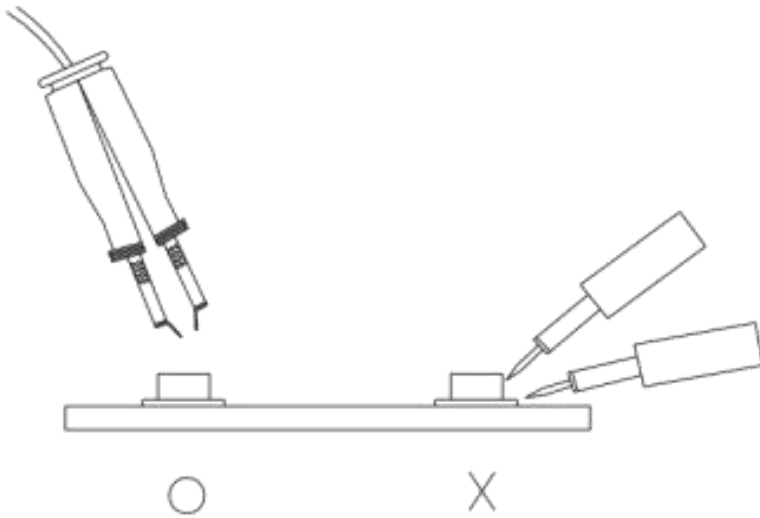

---

## 使用注意事项

---

### Precautions

**XL-ITR20403**由红外发射二极管和 NPN 硅光晶体管组成，它们并排封装在黑色热塑性外壳中的汇聚光轴上。光电晶体管只接收来自IR的辐射。这是正常情况。但当物体在中间时，光电晶体管不能接收辐射。有关更多组件信息，请参阅IR和PT。

XL-ITR20403 It is composed of infrared emission diode and NPN silicon photo transistor, which are packaged side by side in black On the converging optical axis in the thermoplastic shell. Photo transistor only receives radiation from IR. This is normal Condition. But when the object is in the middle, the photo transistor cannot receive radiation. For more component information, please Refer to IR and PT.

#### \* 注意: Note

1 、铅焊料温度剖面

Lead solder temperature profile

2 、波峰焊不应做一次以上

Peak welding shall not be done more than once

3 、焊接时，不要在加热过程中对 LED 施加压力

When soldering, do not put stress on the LED during heating

4 、焊接后，不要使电路板翘曲

After soldering, do not warp the circuit board